

# Fair Bandwidth Sharing based Additive-Increase Multiplicative-Decrease (FBAIMD) Congestion control Algorithm for WSN.

Vikram Singh, Rishav Dewan

**Abstract**—To ensure fair bandwidth sharing between multiple sources sharing the same link congestion control is an essential mechanism at the transport layer to regulate traffic flows for bandwidth consumption. Congestion control is the main factor in maintaining the QoS for the wireless sensors networks. WSN are the adhoc networks which once deployed in a particular environment to monitor specific physical phenomena are very difficult to maintain the QoS requirement throughout the Network life time. So, very sophisticated and adaptive algorithms are needed to maintain the QoS requirement of the network. This paper presents the Fair Bandwidth sharing based Additive Increase Multiplicative decrease (FBAIMD) congestion control algorithm.

**Index Terms**— WSN (Wireless sensors Networks), QoS, Additive Increase Multiplicative Decrease (AIMD), Fair bandwidth sharing based Additive Increase Multiplicative Decrease (FBAIMD).

## I. INTRODUCTION

Additive Increase Multiplicative Decrease (AIMD) law used by the two sources to adapt their sending rates to the feedback from the network on whether the link is congested or not, leads to a stable equilibrium point of network operation which is both fair and efficient. Moreover this model clarifies several basic features of a typical congestion control algorithm used in the Internet. But most of the AIMD Algorithm converges to a point which does not satisfies the need for the fast changing data rates of the sources. AIMD although leads to the equal bandwidth share between two sources sharing the same link but in a fast changing data rate environment this leads to the ineffective link utilization. So, there is a need for the algorithm to converges to a point according to the changing data rate of the sources i.e adaptive algorithm is needed.

## II. RELATED WORK

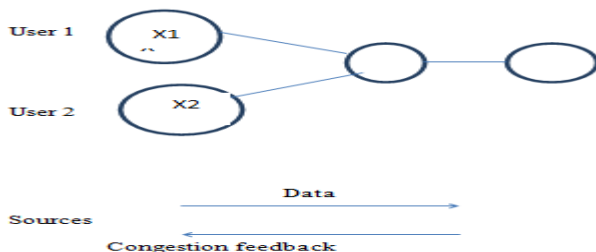

Figure 1. Resources Allocation in AIMD Model

Manuscript received August 19, 2014.

Vikram Singh ( M.Tech Student), Bhai Gurdas Institute of Engg. & Technology, Sangrur.

Rishav Dewan (Assistant Profesor), Bhai Gurdas Institute of Engg. & Technology, Sangrur

Figure 1 shows two sources share a common link that has a capacity  $c$  packets/sec. In [1] and [2]  $x_i$  is the rate at which source  $i$  sends packet into the network, for  $i = 1, 2$ . The link provides feedback to the sources to indicate whether the link access rate  $x_1 + x_2$  exceeds the link capacity or not. The term congestion refers to the situation where the link access rate exceeds the link capacity. The feedback signal from the link to the sources is  $I(x_1 + x_2 > c)$ , the indicator function of the event  $(x_1 + x_2 > c)$ . It takes the value 1 when the event  $(x_1 + x_2 > c)$  is true and the value 0 when the event is false. The congestion control problem here is to adapt the sending rate of the sources to the feedback signal so that the link can be shared fairly and fully utilized corresponding to convergence of the sending rates of the sources to a stable operating point, which realizes the unique equilibrium of the network. In response to the congestion signal, the sources adjust their sending rates according to the differential equation

$$\dot{x}_i = \alpha I(x_1 + x_2 \leq c) - \beta x_i I(x_1 + x_2 > c) \text{ for } i \in \{1, 2\} \quad (1)$$

Here  $\dot{x}_i$  refers to the time derivative of  $x_i$  i.e.,  $dx/dt$  and  $\alpha$  and  $\beta$  are positive constants.

The equation (1) says that if the total arrival rate at the link does not exceed the capacity then a source increases its sending rate at a constant rate  $\alpha$  (additive increase) and if the link arrival rate exceeds the link capacity, then the sending rate is decreased multiplicatively (as  $\dot{x}_i$  is proportional to  $-x_i$ ) with  $\beta$  as the constant of proportionality. Note that the two events  $x_1 + x_2 \leq c$  and  $x_1 + x_2 > c$  are complementary, in the sense that at any instant exactly one of them is true. An assumption implicit in the model is that the network delays are negligible so that the feedback is modeled as instantaneous.

To study the behavior of the system, set the variable

$$y = x_1 - x_2 \quad (2)$$

which leads to a simplified differential equation involving  $y$  obtained from the equation (1) by simple algebra.

$$\dot{y} = -\beta y I(x_1 + x_2 > c) \quad (3)$$

So when  $x_1 + x_2 \leq c$ ,  $\dot{y} = 0$ , indicating that  $y$  does not change with time, and so  $(x_1 - x_2)$  remains a constant. However (1.1) implies that  $x_1$  and  $x_2$  increase steadily under this condition. So when  $(x_1 + x_2) \leq c$ , both  $x_1$  and  $x_2$  increase steadily at the same rate while maintaining their difference constant. In

## Fair Bandwidth Sharing based Additive-Increase Multiplicative-Decrease (FBAIMD) Congestion control Algorithm for WSN.

the case when  $(x_1+x_2) \geq c$ , equation (2) indicates that  $y$  evolves to reduce the difference between  $x_1$  and  $x_2$  and as  $t \rightarrow \infty, (x_1 + x_2) \rightarrow c$  and  $y = (x_1 - x_2) \rightarrow 0$ . Thus in the steady state, the network attains the equilibrium where the link is fully utilized as  $(x_1 + x_2) \rightarrow c$  and is equally shared by the two senders as  $(x_1 - x_2) \rightarrow 0$ .

### A. Observations of AIMD

Several features of the AIMD are noteworthy as they reflect the characteristics that are desired in any congestion control algorithm designed to operate in a complex network like the Internet.

### B. Resource Sharing principle/mechanism in AIMD

The sources adapt their sending rate to the extent of congestion in the network by decreasing the sending rates if the link arrival rate is in excess of the link capacity and by increasing the sending rate if the link arrival rate below the link capacity. Note that the dynamic allocation of resources (such as link capacity in this case) is fundamental in deriving the benefits of packet switching.

### C. Feedback of congestion detection

The congestion control algorithm responds to feedback from the network about the presence or absence of congestion in the form of the congestion signal  $I(x_1+x_2 > c)$  obtained from the congestion event  $(x_1 + x_2 > c)$ . The amount of feedback is minimal, it is a single bit of information indicating whether the link arrival rate exceeds the link capacity or not. If the link merely drops packets, the receiver can detect the loss of packets and inform the source about the presence of congestion in the network.

### D. AIMD Congestion Control Algorithm

The congestion control algorithm steers the network towards an operating point which corresponds to a unique stable equilibrium for the operation of the network which is both efficient and fair. A good congestion control algorithm should provide a rate region that is as large as possible while supporting (some form of) fairness in allocating the rates to the different users.

### E. Decentralized Operation

Each source (congestion controller) utilizes one-bit feedback from the network and the different sources need not communicate with one another. A link can signal congestion based on the total arrival rate at the link.

### F. Mathematical modeling of AIMD

Appropriate discretization of the differential equation leads to a difference equation that can be implemented as a computer program. The difference equation is obtained from the original differential equation as follows.

The original differential equation (1) is  $\dot{x}_i = \alpha I(x_1 + x_2 \leq c) - \beta x_i I(x_1 + x_2 \geq c)$  for  $i \in \{1, 2\}$

The main step here is to replace the continuous derivative by its discrete counter-part

$$\frac{dx}{dt} \approx \frac{x(t+\Delta t) - x(t)}{\Delta t}$$

In the difference quotient, replace  $x(t+\Delta t)$  by  $x(k+1)$ ,  $x(t)$  by  $x(k)$  and  $\Delta t$  by  $\delta$  and then substitute and simplify to get

$$x(k+1) = x(k) + \alpha \delta I(x_1 + x_2 \leq c) - \beta \delta x(k) I(x_1 + x_2 > c) \quad (4)$$

## III. PROPOSED WORK

There are various congestion control algorithms like Random Early Detection (RED), Back Pressure Technique, Choke Packet Technique, Implicit congestion Technique etc. among other congestion techniques. Additive-Increase multiplicative-decrease (AIMD) algorithm is also used to reduce congestion in WSN but it has the serious drawback of convergence to a point where there is unfair allocation to the multiple sources which causes:

- Un-Optimized use of link capacity
- More dropout of data packets
- Reduce efficiency of network

To overcome the existing problem of AIMD, the main objective of this paper is to develop an Adaptive AIMD (FBAIMD) algorithm which detects congestion like AIMD and is likely to address the limitations of AIMD algorithm and will improve the following parameters:-

- Effective utilization of link capacity among multiple sources
- Reduce the dropouts of data packets
- Increase the efficiency of the network

### A. FBAIMD Description

In AIMD nodes adapt their data sending rate only on the basis of their output data rate, in these algorithms there is no role of their input data receiving rate. In [3] node output data rate depends on the nodes input data rate described below:

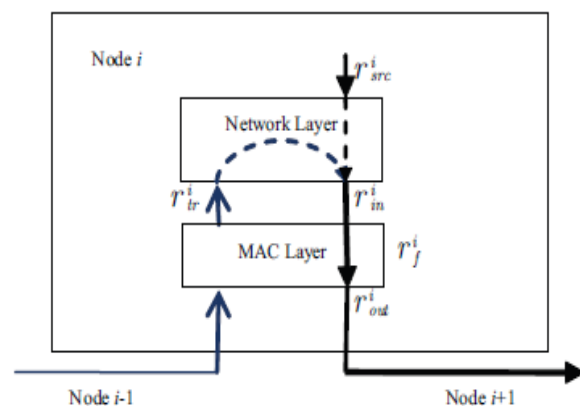

Figure 2. The queuing model at a particular sensor node

Let  $i$  be the node in WSN. In MAC layer the transit traffic of node  $i$  is  $r_{tr}$  which is received from its child nodes such as node  $i-1$ . Before forwarding the packets from node  $i$  to its next node  $i+1$  both the transit traffic and the source traffic converge at the network layer by the parent node of  $i$ . The total input traffic rate of node  $i$  at MAC layer is,

$$r_{in}^i = r_{src}^i + r_{tr}^i \quad (5)$$

When this total input traffic rate  $r_{in}$  greater than packet forwarding rate  $r_f^i$  packets could be queued at MAC layer. The packet output rate at the node  $i$  is  $r_{out}^i$  which is forwards to its next node  $i+1$ . If  $r_{in}^i$  is smaller than  $r_f^i$ , then  $r_{out}^i$  is equals to  $r_{in}^i$

If  $r_{in}^i < r_f^i$

then,  $r_{out}^i = r_{in}^i$

Otherwise, If  $r_{in}^i$  is greater than  $r_f^i$ , then  $r_{out}^i$  will be close to  $r_f^i$  i.e. If  $r_{in}^i > r_f^i$

then,  $r_{out}^i \approx r_f^i$ ,  
 $r_{out}^i$  close to  $r_f^i$

But,

Therefore, we can say,

$$r_{out}^i = \min(r_{in}^i, r_f^i) \quad (6)$$

This shows that output data rate of node depends on the input receiving or input forwarding rate of the node. Let the ratio of the output data rate to the input data rate be  $R$

$$R = r_{out}^i / r_{in}^i \quad (7)$$

In equation 2.4 there is same  $\alpha$  and  $\beta$  for both sources and more over they did not consider the input data rate which results in unfair reduction of the rate when congestion is detected for example whichever sources has more current output data rate its reduction in output data rate is also higher than the source which has lesser current output data rate irrespective of their input data rate. Let the two sources have their respective data rate ratio be  $R_1$  and  $R_2$  and let there are two constants  $\alpha_1, \alpha_2$  and  $\beta_1, \beta_2$ . According to the FBAIMD the current  $\alpha$  and  $\beta$  of the sources will be

If  $R_1 \leq R_2$  then current  $\alpha$  and  $\beta$  of the 1<sup>st</sup> source will be  $\alpha = \min(\alpha_1, \alpha_2)$

$$\beta = \max(\beta_1, \beta_2)$$

and current  $\alpha$  and  $\beta$  of the 2<sup>nd</sup> source will be

$$\alpha = \max(\alpha_1, \alpha_2)$$

$$\beta = \min(\beta_1, \beta_2)$$

Else

Vice-Versa

#### IV. PERFORMANCE EVALUATION AND SIMULATION RESULTS

We used Matlab for the simulation of AAIMD model. In Figure 3 in case of network is congested both sources reduce their packet rate at the same rate i.e after point (0.65,0.45) the rate of reduction is same on both axis, the result of which is that AIMD converges to a point where there is equal bandwidth is allotted to both sources irrespective of their input data rate. Figure 5 also shows the same result for different initial bandwidth for sources. Figure 4 and 6 shows the convergence of the FBAIMD i.e after point (0.65,0.45) the rate of reduction /rate of packet drop out is different for both sources depending on their input data rate. Figure 7 shows the comparison of the two algorithms for the same initial input.

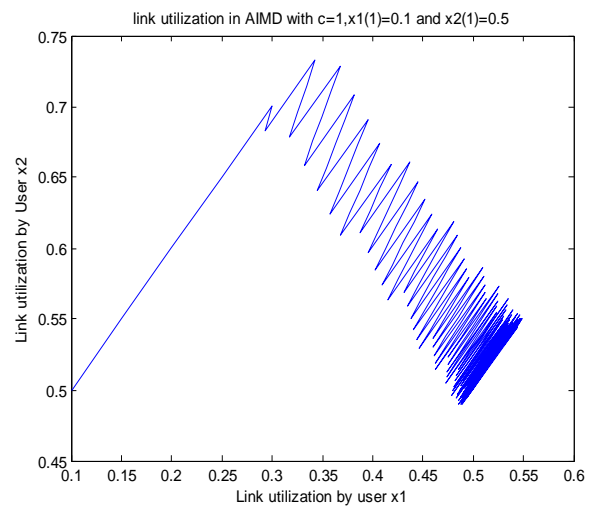

Figure 3. Rate evolution of the the AIMD Algorithm for two sources sharing a single link of capacity one. Starting from the point (0.1,0.5), the system move towards the point (0.5,0.5).

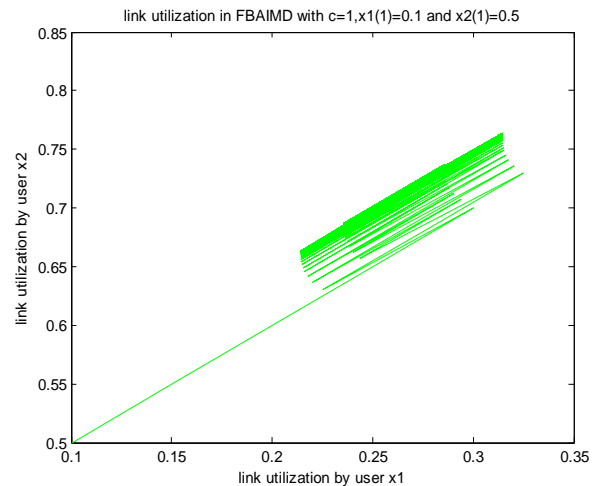

Figure 4. Rate evolution of the FBAIMD Algorithm for two sources sharing a single link of capacity one. Starting from the point (0.1,0.5), the system move towards the point (0.25,0.7).

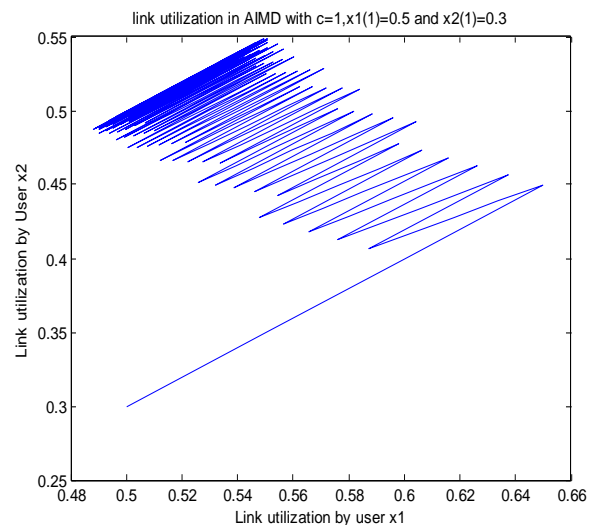

Figure 5. Rate evolution of the the AIMD Algorithm for two sources sharing a single link of capacity one. Starting from the point (0.5,0.3), the system move towards the point (0.5,0.5).

REFERENCES

- [1] Dah-Ming Chiu and Raj Jain, "Analysis of the increase and decrease algorithms for congestion avoidance in computer networks," *Journal of Computer Networks and ISDN Systems*, Volume 17 Issue 1, June 1989 Pages 1 - 14.
- [2] R. Srikant, "The Mathematics of Internet Congestion Control". Birkhauser, 2004.
- [3] DiptiPatil, Sudhir N. Dhage "Priority-based Congestion Control Protocol (PCCP) for Controlling Upstream Congestion in Wireless Sensor Network" *IEEE International Conference on Communication, Information & Computing Technology (ICCICT)*, Oct. 19-20, pp. 1-6, 2012
- [4] Dizhi Zhou, Wei Song, Yu Cheng; "A Study of Fair Bandwidth Sharing with AIMD-Based Multipath Congestion Control" *IEEE Wireless Communications letters Journal*, vol. 2, no. 3, pp. 299-302, June 2013
- [5] Chengdi Lai, Ka-Cheong Leung, and Victor O.K. Li; "Design and Analysis of TCP AIMD in Wireless Networks" *2013 IEEE Wireless Communications and Networking Conference (WCNC): Networks*, pp.1422-1427, 2013
- [6] Łukasz Budzisz, Rade Stanojević, Arieh Schlote, Fred Baker, and Robert Shorten "On the Fair Coexistence of Loss- and Delay-Based TCP" *IEEE/ACM transactions on Networking*, vol. 19, no. 6, pp. 1811-1824, December 2011
- [7] Oussama Habachi, Hsien-Po Shiang, Mihaela van der Schaar, *Fellow, IEEE*, and Yezekael Hayel "Online Learning Based Congestion Control for Adaptive Multimedia Transmission" *IEEE transactions on signal processing*, vol. 61, no. 6, march 15, 2013
- [8] Qinghua Ye, S. Hossein Mortazavi, Mike H. MacGregor, "Performance Analysis of an Optimal Internal Congestion Control in a Cluster-based Router" *IEEE Wireless Communications letters Journal*, vol. 2, no. 3, pp. 249-255, 2012
- [9] <http://ijaracet.org/wp-content/uploads/IJAR CET-VOL-3-ISSUE-3-935-940.pdf>

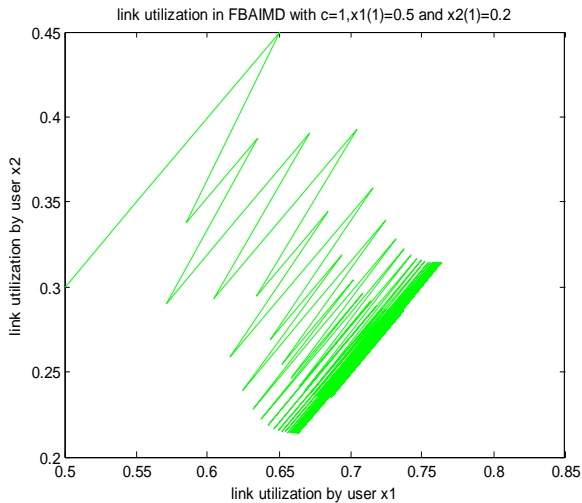

Figure 6. Rate evolution of the the FBAIMD Algorithm for two sources sharing a single link of capacity one. Starting from the point (0.5,0.2), the system moves towards the point (0.28,0.73).

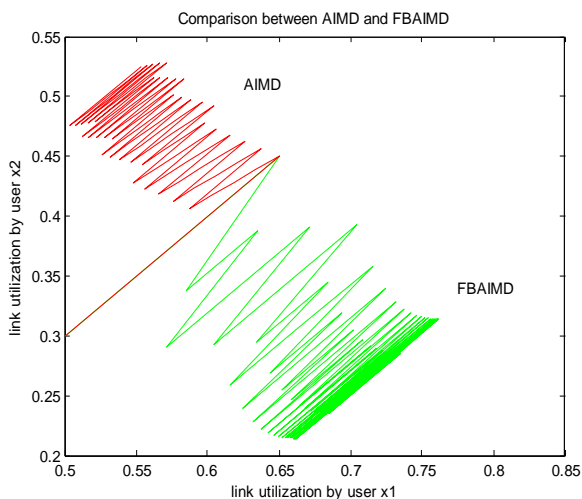

Figure 7. Comparison of the rate evolution of the the AIMD Algorithm and FBAIMD Algorithm for two sources sharing a single link of capacity one with same initial input.

V. CONCLUSION

In this paper, Adaptive Additive Increase Multiplicative decrease (AAIMD) congestion control algorithm is developed, conventional Additive Increase Multiplicative decrease (AIMD) congestion control algorithm has the drawback of inefficient utilization of the link capacity in case of the multiple sources sharing the same link. It also results in more dropout of data packets during congestion of the link. Proposed AAIMD algorithm adapts according to the need of the continuous changing data rate of the sources and use the the link bandwidth according to the data rates of the sources. Simulation results shows that algorithm converges to a point depending on the input data rate of the sources which results in lesser dropout of the packets and greater utilization of the link capacity.